

# ***ViaLiteHD*** **Fibre Optic Green OEM Link Modules**

## **User Manual**

ViaLiteHD-Green-OEM-Link-HB-2 Handbook

CR4651

21/12/2020



## Contents

1.	Introduction .....	4
2.	Connectors .....	4
2.1	Connecting and Disconnecting Optical Connectors .....	4
2.2	Connecting and Disconnecting RF Connectors .....	4
2.3	Alarm Output .....	4
3.	Part Numbering .....	5
4.	Module interfaces .....	5
4.1	Monitor Output (TX modules only) .....	5
4.2	Received Light Level (RX modules only) .....	5
4.3	LNA Feed (TX modules only) .....	5
5.	LED Indicator .....	5
6.	Technical Specification .....	5
7.	Module Dimension and Mounting Footprint .....	6
8.	Module performance graphs .....	7
8.1	Frequency Response and Link Gain .....	7
8.2	System Performance vs Temperature .....	7
9.	Product warranty .....	8
10.	FCC Approval .....	8

## ESD Precautions



Precautions for handling electro-static sensitive devices should be observed when handling the **ViaLiteHD** RF transmitter and receiver modules.

## Optical Safety



The **ViaLiteHD** RF transmitter modules contain laser diode sources operating at 1300nm / 1550nm. These devices are rated at under EN60825-1 as CLASS 1 radiation emitting devices.

- Never look into the end of an optical fibre directly or by reflection either with the naked eye or through an optical instrument.
- Never leave equipment with radiating bare fibres accessible – always cap the connectors.
- Do not remove equipment covers when operating.

Adjustment, maintenance and repair of the equipment should only be carried out by suitably qualified personnel.

This product is supplied with angle-polished connectors and these must not be confused with standard flat, spherical or "super" polished connectors. These connector types are not interchangeable and mating one with the other will damage both the cable and the equipment.

The specification of the optical connector is critical to the performance of the complete fibre optic link. System performance can only be guaranteed with fibre optic cables and connectors supplied by **ViaLite Communications**.

## 1. Introduction

The **ViaLiteHD** RF Fibre Optic Links (FOLs) are a family of fibre optically coupled link systems designed for the transmission of RF analogue signals. **ViaLiteHD** is a product brand manufactured by Pulse Power and Measurement Ltd (PPM). **ViaLite Communications** is a division of Pulse Power and Measurement Ltd (PPM).

## 2. Connectors

### 2.1 Connecting and Disconnecting Optical Connectors

Before connecting optical fibres to the module or to each other, ensure that the mating connectors are clean. Please read the cleaning instructions which accompany the connector cleaning kit.

- To connect **FC/APC** optical connectors, remove the dust caps and align the white ceramic centre ferrule on the cable connector with the receptacle. There is a lug on the side of the ferrule, which must match the gap in the receptacle shroud. When they are aligned, gently push the plug home and finger tighten the knurled collet nut onto the threaded receptacle. To disconnect, unscrew the knurled collet on the plug and gently withdraw the plug. Replace the dust caps on both the receptacle and plug.
- To connect **E2000/APC** optical connectors, gently push the plug into the E2000 adapter until a click is heard and the connector locks. To disconnect, depress the lever at the rear of the connector and withdraw the connector.
- To connect **SC/APC** optical connectors, remove the dust caps and align the white ceramic centre ferrule on the cable connector with the receptacle. Align the key of the plug with the slot in the receptacle. Gently push the plug into the adapter until a click is heard and the connector locks. To disconnect grip the body of the plug and gently pull the plug from the adaptor, replace the protective cover.

Note that minimum bend radius of fibre optic cable is 50mm.

### 2.2 Connecting and Disconnecting RF Connectors

- Module with **SMA** RF connectors. Connect the cable to the module, screw the cable connector onto the module connector to finger tightness, then use an SMA torque spanner to tighten the connector to the specified torque. To remove the connector, loosen the connector with an 8mm spanner, and then remove the connector using fingers.
- Module with **MCX** RF connectors. Connect the cable by aligning to plug and jack, then firmly push home ensuring the connector is fully engaged.

### 2.3 Alarm Output

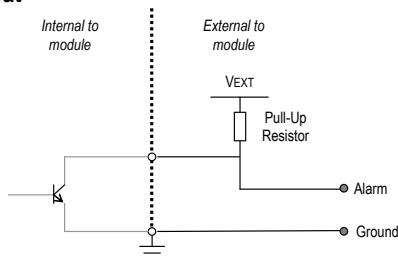

Transmitter Module Alarm Output: Laser failed or seriously degraded

Receiver Module Alarm Output: No received optical signal (optical loss > 18dB)

"Alarm" condition is active high - see diagram  
i.e. OKAY = Alarm pin shorted to Ground  
ALARM = Alarm pin open circuit

Maximum current through alarm circuit = 50mA  
VEXT allowable range = +1VDC to +15VDC

### 2.4 14 way connector

Pin Number	Cable Colour	Function
1	Pink	Not used
2	Pink	Do not use, otherwise may cause damage
3	Pink	Not used
4	Pink	Do not use, otherwise may cause damage
5	Orange	Alarm Output (Open Drain)
6	Pink	Not used
7	Red	+12.0VDC Supply to Module
8	Black	Supply 0VDC Return
9	Pink	Not used
10	Purple	Not used
11	Black	Supply 0VDC Return
12	Pink	Not used
13	White	Tx: LNA Feed*, Rx: not used
14	Green	Analogue Monitor Output. Tx: Laser Current. Rx: RLL

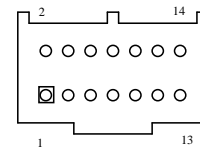

Top view of the 14-pin header

- Note:
- Cable assembly part number 73664 (supplied) for connection to the module fitted with Molex connector.
  - LNA feed is fused with 0.75A hold and 1.5A trip. Feed voltage -28VDC to +28VDC.

### 3. Part Numbering

For part numbering please refer to the relevant datasheet which can be found on our website or contact us.

### 4. Module interfaces

#### 4.1 Monitor Output (TX modules only)

The forward current monitor (IFL) gives an absolute measure of the laser drive current.

$$V_{IFL} = 25 \times I_{fwd} \text{ (A)}$$

E.g. Laser drive current of 40mA, produces 1V. Typical room temperature range is 20 to 50mA. Normal thresholds are: min. 10mA, max. 100mA.

The LED indicator will show red colour if the laser current is outside of this window.

#### 4.2 Received Light Level (RX modules only)

The Received Light Level (RLL) monitor gives a relative measure of the optical power at the receiver module.

$$V_{RLL} = 4V \text{ at the nominal system gain with 1m fibre}$$

Reduces by 0.075V per dB of RF link loss, due to additional loss in the optical path.

E.g. if the measured RLL voltage is 3.25V, the expected link RF gain is 10dB below the nominal gain, and the overall additional optical loss is 5dB.

#### 4.3 LNA Feed (TX modules only)

Modules with LNA feed "option 3" route a user fed LNA voltage through PIN 13 on the 14-way header to the RF input connector on the modules. Modules in this range **DO NOT** offer **INTERNALLY** generated LNA feed voltages.

### 5. LED Indicator

Each module is fitted with a single LED for status indication.

- **GREEN** LED Normal operation
- **RED** LED Serious Fault
  - TX:** Laser diode out of specification or end of life
  - RX:** No received optical signal (optical loss > 18dB)
- No light Indicates the module has not been powered up

### 6. Technical Specification

	Units	Note	0dB Link Gain	+9dB Link Gain
Transmitter, Typical			HRT-V1-6B-35-S1310	HRT-V1-6B-33-S1310
Receiver, Typical			HRR-V1-6B-05	HRR-V1-6B-03
Frequency range	MHz		100-1000	
Impedance, RF connector			50Ω SMA	
VSWR	(typ)		1:1.5	
Link gain (TX gain / RX gain)	dB (nom)	<sup>a</sup>	0 (-15 / +15)	+9 (-11 / +20)
Flatness, fullband, max / typ	dB	<sup>ah</sup>	±1.0 / ±0.3	
Gain stability over temperature, Link	dB (max)	<sup>a</sup>	±3	
Gain stability with temperature, Tx/Rx	dB/°C (typ)	<sup>a</sup>	0.05/0.03	
Gain stability	dB (typ)		0.25 @ 24 hrs	
P1dB <sub>input</sub>	dBm (typ)	<sup>ak</sup>	2	-1
IP3 <sub>input</sub>	dBm (typ)	<sup>ak</sup>	14	11
Noise figure	dB (typ)	<sup>ak</sup>	23	19
Noise figure, 5dB optical loss	dB (typ)	<sup>ck</sup>	28	24
SFDR	dB/Hz <sup>2/3</sup> (typ)	<sup>a</sup>	110	
Maximum input power, no damage	dBm (min)		15	
LNA feed			External -28V to +28V from 14-way header. Internal fuse 750mA hold and 1500mA trip.	
Power Tx, max / typ	W		1.4 / 1.1	
Power Rx, max / typ	W		1.0 / 0.8	

Optical connector			E2000 (optional FC/APC and SC/APC)	
Optical wavelength	nm		1310 ± 20 (optional 1550nm and CWDM)	
Laser type			DFB - Distributed feedback laser	
Optical power output	dBm (typ)		4.5	
Summary alarm output			Open drain alarm: OPEN: Alarm, CURRENT SINK: okay	
Operating temperature range			-10°C to +50°C	
Storage temperature range			-40°C to +70°C	
Humidity	RH		95% non-condensing humidity	

<sup>a</sup> nominal input power @ 0dB optical loss

<sup>c</sup> nominal output power @ 5dB optical loss

<sup>h</sup> default gain setting

<sup>k</sup> Measured @ 500MHz

All tests @ 25°C after 15 minutes warm up

**7. Module Dimension and Mounting Footprint**

The following figures give the dimensions of two kinds of module formats available.

- “C” type, i.e. module part number HRx-xx-xC-xx-xxxxx, supplied with an adaptor plate compatible with **ViaLite** Classic product line.
- “B” type, ie module part number HRx-xx-xB-xx-xxxxx, supplied with 3 stand-offs

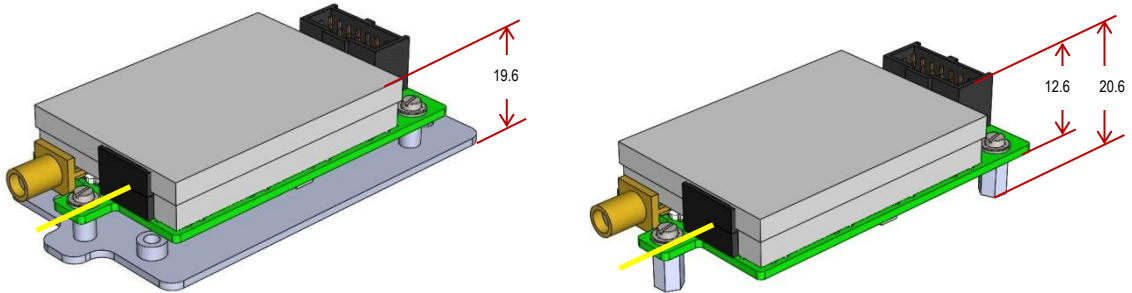

Fibre connector is not shown, for clarity  
 Typical fibre length is 25cm measured from tip of connector to module body

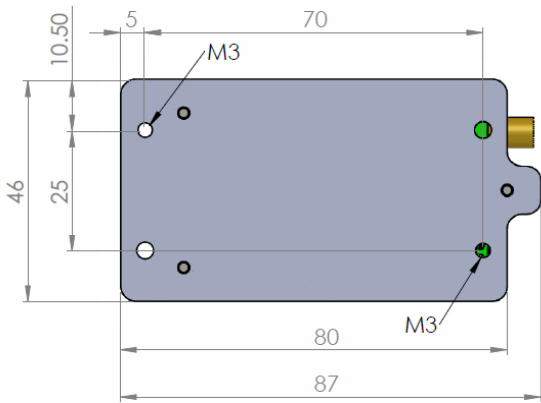
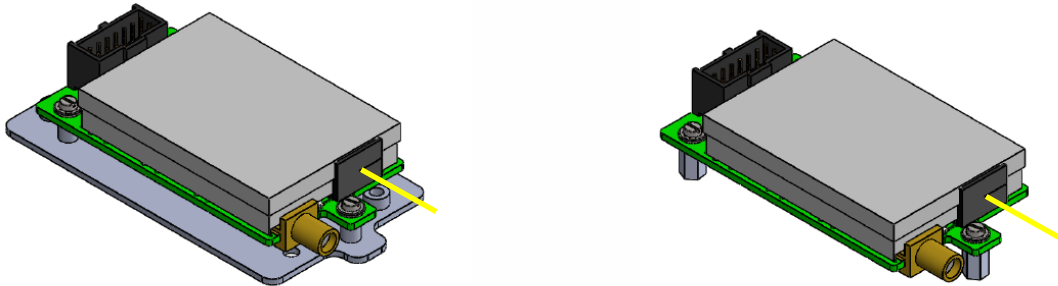

C type module with an adaptor plate, in mm  
 View looking from bottom of the module

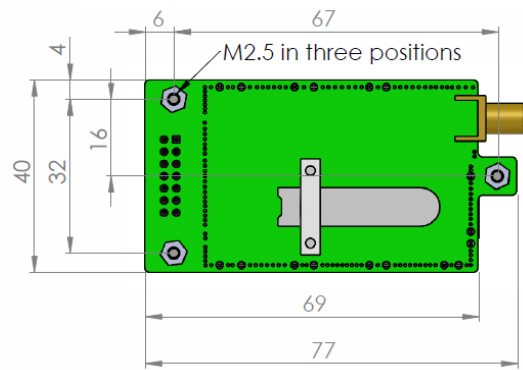

B type module with stand-off, in mm  
 View looking from bottom of the module

## 8. Module performance graphs

### 8.1 Frequency Response and Link Gain

Typical Tx (left) and Rx (right) frequency responses @0dB optical loss are given below.

To work out the gain for the whole link, simply add Tx gain and Rx gain together and then take away twice the optical loss (in dB).

For example, if Tx gain is -11dB, Rx gain is 20dB and the optical loss due to the fibre and connectors is 2dB, the total gain will be 5dB (-11+20-4=5).

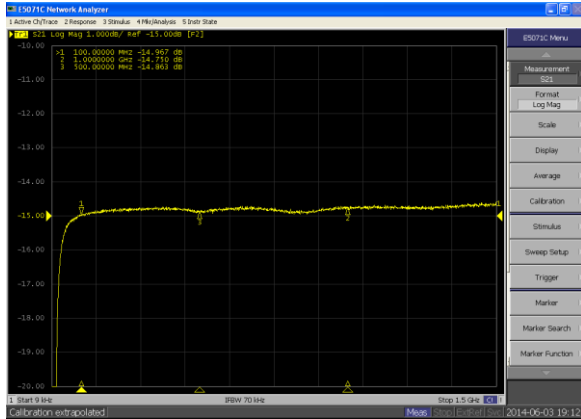

Typical Tx module response

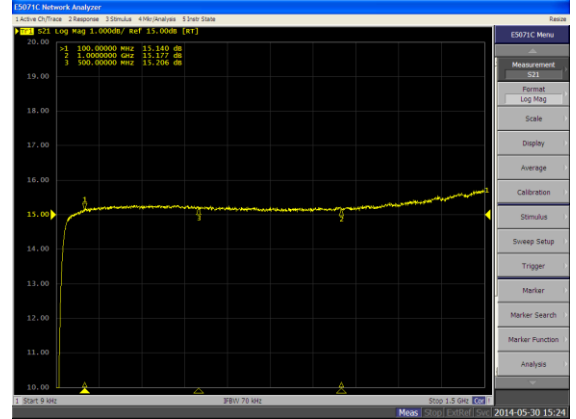

Typical Rx module response

### 8.2 System Performance vs Temperature

The following plots show typical performance variation @ 950MHz with temperature. The actual performance of each module may vary slightly.

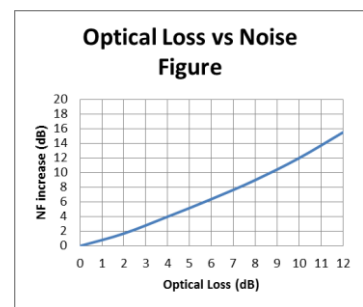
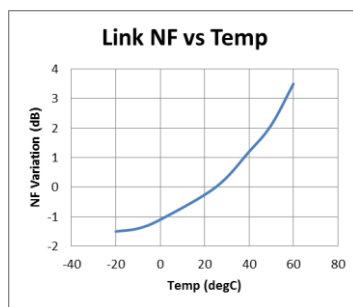
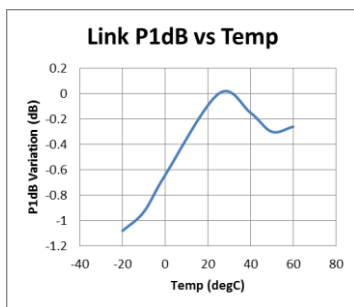
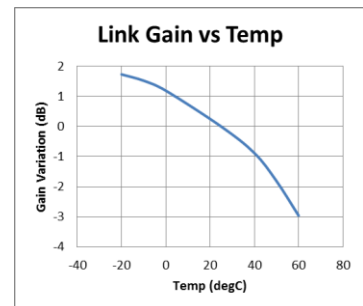
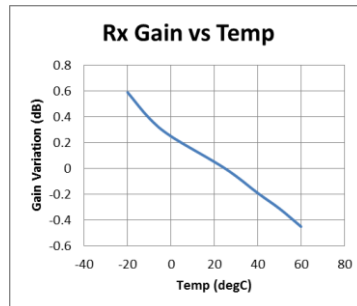
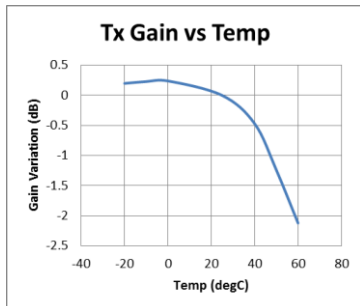

## 9. **Product warranty**

The guarantee / warranty period, unless otherwise agreed in writing, shall be as stated in document F292 - PPM Manufactured Product – Warranty, which is available at: <https://ppm.co.uk/warranty-periods/>. Extended warranty options are available at the time of purchase.

Prior to returning any goods for warranty or non-warranty repairs please contact PPM / **ViaLite Communications** for a returns reference.

## 10. **FCC Approval**

Information to the user of **ViaLiteHD** products.

For a Class A digital device or peripheral, the following instructions are furnished to the user. This equipment has been tested and found to comply with the limits for a Class A digital device, pursuant to part 15 of the FCC Rules. These limits are designed to provide reasonable protection against harmful interference when the equipment is operated in a commercial environment. This equipment generates, uses, and can radiate radio frequency energy and, if not installed and used in accordance with the instruction manual, may cause harmful interference to radio communications. Operation of this equipment in a residential area is likely to cause harmful interference in which case the user will be required to correct the interference at his own expense.

© PULSE POWER & MEASUREMENT LTD 2020.

NO PART OF THIS DOCUMENT MAY BE REPRODUCED OR TRANSMITTED IN ANY FORM WITHOUT PRIOR WRITTEN PERMISSION.

PULSE POWER & MEASUREMENT LTD, 65 SHRIVENHAM HUNDRED BUSINESS PARK, SWINDON, SN6 8TY, UK.

TEL: +44 1793 784389 FAX: +44 1793 784391

EMAIL: [SALES@VIALITE.COM](mailto:SALES@VIALITE.COM) WEBSITE : [WWW.VIALITE.COM](http://WWW.VIALITE.COM)