

ViaLiteHD 6 GHz Link Handbook

User Guide

HRx-Y-HB-6

CR6980

19/02/2026

Instrument Care and Safety Information

Please read the whole of this section before using your **ViaLiteHD** product. It contains important safety information and will enable you to get the most from your Fibre Optic link.

Electrical Safety



The **ViaLiteHD** chassis is a Safety Class 1 product (having metal chassis directly connected to earth via the power cable).

When operating the equipment note the following precautions:

- Hazardous voltages exist within the rack mounted equipment.
- There are no user serviceable parts inside; the covers **MUST NOT** be removed.
- There are no user replaceable fuses in the chassis mounted equipment or OEM modules.
- The chassis earth stud **SHOULD** be connected to the safety earth.
- When using a 2 pin power supply cable the chassis earth stud **MUST** be connected to the safety earth.
- The **ViaLiteHD** Power Supply Modules do not have an isolating switch on the mains voltage inlet. For this reason, the **ViaLiteHD** chassis **MUST** be installed within easy reach of a clearly labelled dual pole mains isolation switch, which supplies the equipment.

ESD Precautions



Precautions for handling electro-static sensitive devices should be observed when handling all **ViaLiteHD** modules. Technicians should ensure that they use effective personal grounding (i.e. ESD wrist strap etc.) when servicing the equipment. Any equipment or tools used should be grounded to prevent static charge build-up. Good practice should be observed at all times. For reference see relevant standards.

EN 61340-5-1, "Protection of Electronic Devices from Electrostatic Phenomena – General Requirements"

Optical Safety



The **ViaLiteHD** RF Transmitter and Transceiver modules contain laser diode sources operating at nominal wavelengths of 1270nm to 1610nm.

These devices are rated as EN60825-1 CLASS 1 radiation emitting devices. A class 1 laser is safe under all conditions of normal use.

When operating the equipment note the following precautions:

- Never look into the end of an optical fibre directly or by reflection either with the naked eye or through an optical instrument.
- Never leave equipment with radiating bare fibres – always cap the connectors.
- Do not remove equipment external covers when operating.

Hot surface



The **ViaLiteHD** systems may have hot surfaces when operating under full load. The hot surfaces are not accessible when fitted in an approved chassis installation. Hot surfaces will be appropriately marked

Suitable precaution should be taken when handling this device.

- Allow to cool for 10 minutes
- Do not touch metallic surfaces or printed circuit board when hot.
- When handling, hold front panel and handle only.

TABLE OF CONTENTS

| | | |
|---------|---|----|
| 1 | INTRODUCTION | 5 |
| 1.1 | Typical deployment..... | 5 |
| 1.2 | <i>ViaLiteHD</i> compatibility..... | 5 |
| 1.3 | Care of fibre optic connectors..... | 5 |
| 2 | SETUP AND OPERATION OF THE FIBRE OPTIC LINK | 6 |
| 2.1 | Module Type overview..... | 6 |
| 2.1.1 | Rack plug-in modules..... | 6 |
| 2.1.2 | Blue OEM | 7 |
| 2.1.2.1 | Power supply..... | 7 |
| 2.1.3 | Black IP rated OEM..... | 8 |
| 2.1.3.1 | Mounting and sealing..... | 8 |
| 2.1.3.2 | Power supply..... | 8 |
| 2.2 | Fibre optic interface | 9 |
| 2.2.1 | Connector and cable types..... | 9 |
| 2.2.2 | Connecting and disconnecting | 9 |
| 2.2.3 | Cleaning optical connectors, cleaning before every use | 9 |
| 2.2.4 | Cleaning optical connectors, high levels of contamination | 9 |
| 2.2.5 | FC/APC Connectors..... | 10 |
| 2.2.6 | SC/APC Connectors..... | 11 |
| 2.2.7 | Minimum bend radius | 11 |
| 2.3 | RF Interface | 11 |
| 2.3.1 | SMA connections | 11 |
| 2.4 | Front panel indicators | 12 |
| 2.4.1 | Rack plug-in modules- LEDs..... | 12 |
| 2.4.2 | Blue and Black OEM LED | 12 |
| 2.5 | I/O connections and features..... | 13 |
| 2.5.1 | Analogue monitors | 13 |
| 2.5.2 | RF Bias-T | 13 |
| 2.5.3 | Active antenna failure detection (AFD) | 14 |
| 2.5.4 | Alarm voltage..... | 14 |
| 2.5.5 | Blue OEM 10 pin user connector | 14 |
| 2.5.6 | Receiver RLL AGC function | 15 |
| 2.6 | Dual Rack plug-in modules..... | 15 |
| 2.7 | USB CLI command and control | 15 |
| 2.7.1 | Connection configuration..... | 16 |
| 2.7.2 | Command set | 16 |
| 2.8 | Rack plug-in modules web interface..... | 16 |
| 3 | SYSTEM INTEGRATION..... | 18 |
| 3.1 | Link gain | 18 |
| 3.1.1 | Transmitter gain..... | 18 |
| 3.1.2 | Fibre loss..... | 18 |
| 3.1.3 | Receiver gain..... | 18 |
| 3.1.4 | Gain selection for optimum link performance | 19 |
| 3.2 | Frequency response | 20 |
| 3.3 | VSWR | 20 |
| 3.4 | Noise Figure | 20 |
| 3.4.1 | Noise figure vs link loss | 20 |
| 3.5 | P1dB Compression..... | 21 |
| 3.6 | IP3 Linearity | 21 |
| 3.7 | Spurious Free Dynamic Range (SFDR) | 21 |
| 3.7.1 | SFDR vs link loss | 21 |
| 3.8 | Link delay..... | 22 |
| 3.9 | Deviation from linear phase..... | 22 |

| | | |
|-----|-------------------------------------|----|
| 4 | MECHANICAL DETAILS | 23 |
| 4.1 | Blue OEM module dimensions | 23 |
| 4.2 | Blue OEM connector positions | 23 |
| 4.3 | Black OEM module dimensions | 24 |
| 4.4 | Black OEM connector positions | 24 |
| 5 | PART NUMBERING | 25 |
| 6 | TECHNICAL SPECIFICATIONS..... | 26 |
| 7 | MAINTENANCE AND FAULT FINDING | 27 |
| 7.1 | Green status indication | 27 |
| 7.2 | Red status indication | 27 |
| 8 | PRODUCT WARRANTY..... | 28 |

1 Introduction

The **ViaLiteHD** RF Fibre Optic Links (FOLs) are a family of fibre optically coupled link systems designed for the transmission of RF analogue signals over long distances for the communications market.

This handbook covers the following **ViaLiteHD** RF Link part numbers:

- Transmitter modules (*electrical » optical*) with part numbers starting:
 - HRT-Yx-xx-xx-xxxxx
- Receiver modules (*optical » electrical*) with part numbers starting:
 - HRR-Yx-xx-xx
- Transceiver modules (*optical » electrical + electrical » optical*) with part numbers starting:
 - HRX-Yx-xx-xx-xxxxx
- Dual Receiver modules (2x *optical » electrical*) with part numbers starting:
 - HRV-Yx-xx-xx
- Dual Transmitter modules (2x *electrical » optical*) with part numbers starting:
 - HRU-Yx-xx-xx-xxxxx-xxxx

For complete information and product familiarisation, this handbook should be read in conjunction with all other relevant handbooks for your **ViaLiteHD** system.

ViaLiteHD is a product brand manufactured by Pulse Power and Measurement Ltd (PPM).
ViaLite Communications is a division of Pulse Power and Measurement Ltd (PPM).

1.1 Typical deployment

The user's RF electrical signal is input to the transmitter module, which contains RF signal conditioning and laser control circuitry. The module modulates the intensity of a beam of light with the RF signal.

The light travels through an optical fibre to the receiver module. The distance between transmitter and receiver can range from 1m to 100km; distance in excess of 100km can be achieved with more complex optical transport systems, depending on the system specified.

The receiver module converts the modulated light back into an electrical signal, which is available at the output of the module.

1.2 ViaLiteHD compatibility

The RF and optical interfaces are compatible with all **ViaLiteHD** Rack plug-in modules, **ViaLiteHD** Blue OEM modules and **ViaLiteHD** Black OEM IP rated outdoor modules.

18 Laser wavelength options are available for multiplexed applications using CWDM.

Contact **ViaLite Communications** or your local **ViaLite** agent for more details.

1.3 Care of fibre optic connectors

When the fibre optic cables are not connected, it is essential that the cable and equipment connectors are protected by the dust caps provided with the system. Failure to do so may result in damage to the fibre ends which are critical to the system performance. Please refer to section 2.1.3.2 2.2.3 of this document for further details.

2 Setup and operation of the fibre optic link

This section describes the setup and operation of the fibre optic link in the various form factors available.

2.1 Module Type overview

2.1.1 Rack plug-in modules

All **ViaLiteHD** plug-in modules are hot-swappable, so it is not necessary to power-down the chassis before inserting a module. All standard optical connectors are retained by the module, so it will be necessary to either disconnect any cables or have a sufficiently long service loop when removing modules.

To install a 5HP standard module and matching interface plate:

- The protective covers on the connectors may be left in place.
- Push the release button of the module handle down and simultaneously pull the top of the handle towards you.
- Align the module upright and perpendicular to the front face of the chassis so that the PCB slides into the “crow’s feet” card guides top and bottom.
- Gently push the module down its guide, applying pressure via the handle, you may also apply pressure between just above the LEDs.
- As the module is fully mated the top of the handle should snap back and lock in position.
- The pawls of the handle should be fully engaged in the matching slots.
- If power is applied to the chassis the module power LED should light as soon as the module is fully inserted.
- Remove protective covers on the rear interfaces and connect the cables.



To remove a 5HP Standard module

- Disconnect the rear interface cables and fit protective covers.
- Push the release button of the module handle down and simultaneously pull the top of the handle forwards.
- Apply pressure via the handle and gently withdraw the module from the chassis.

2.1.2 Blue OEM

The Blue link module is fully enclosed and built with connectorised interfaces with electromagnetic shielding. This allows system integrators and equipment manufacturers an easy route to build RF/optical interfaces into their own equipment. The small form factor and integrated design should allow the module to be effortlessly integrated into end user equipment. Ensure all RF and optical ports are terminated to user equipment and cabling prior to supplying DC power.



2.1.2.1 Power supply

The Blue OEM can be supplied with a wall mounting OEM power supply (sold separately), with a DC plug connector and international plug (part number: HPS-CP-W). This power supply has capacity to power external RF amplifiers by way of the blue module's internal Bias-T.



2.1.3 Black IP rated OEM

The Black OEM module is an IP55 sealed enclosure suitable for outdoor use. It is ideal for placing close to antennas that are open to the elements. The high gain transmitter module with its low noise figure can in some cases be used without the need for an antenna LNA in downlink applications. If an LNA is required, the built-in Bias-T offers the user a convenient application path.



2.1.3.1 Mounting and sealing

To ensure the IP rating is met, please make sure the USB port bung is replaced after any configuration or maintenance work. Furthermore, ensure the RF and optical connections are wrapped in self-amalgamating tape with the unit mounted vertically such that the cables exit beneath the unit. This will prevent moisture pooling around the connector fittings by allowing gravity to drain it away.

For optimal performance and product longevity, always mount the module shaded from direct sunlight. Ensure all RF and optical ports are terminated to user equipment and cabling prior to supplying DC power.



The IP55 rating is only achieved when the USB bung is tightly sealed and when the RF and Optical ports are wrapped in self-amalgamating tape and vertically mounted with the cables hanging beneath the module. Installation should be carried out by a suitable trained technician.

2.1.3.2 Power supply

The Black OEM module can be supplied with an OEM power connector (sold separately), which has a 2m power tail and bare end (part number: 73955). The power connector is a Hirose part HR30-6PA-3S(71).

Alternatively the Black OEM module can be supplied with a wall mounting, IP rated, OEM power supply (sold separately), that requires an AC mains connections (customer supplied) (part number: HPS-CY). This power supply has capacity to power external RF amplifiers by way of the black OEM module's internal Bias-T.



The AC input must be user terminated inside the box with the available site mains and sealed via the cable gland. The DC side comes pre-fitted with a sealed 2m length of cable and Black OEM power connector.

2.2 Fibre optic interface

2.2.1 Connector and cable types

All **ViaLiteHD** RF modules use single-mode (9µm/125µm) cable terminated in a range of optical connectors detailed below. Cross-site fibre optic cables are available from **ViaLite Communications** as either standard patch leads or heavy-duty multicore cables.



Warning!

Angle polished (APC) and standard (PC) connectors must not be confused. The two connector types are not interchangeable and mating one with the other may damage both the cable and the module connectors.

The specification of optical connector is critical to the performance of the complete fibre optic link. System performance can only be guaranteed with fibre optic cables and connectors supplied by **ViaLite Communications**. When FC/APC connectors are specified they must be “narrow key width”.

2.2.2 Connecting and disconnecting

Before connecting optical fibres to the module or to each other, ensure that the mating connectors are clean (see below).

2.2.3 Cleaning optical connectors, cleaning before every use

Optical connectors **MUST** be cleaned before use, even where they have been protected with dust caps. A large percentage of performance issues can be attributed to dirty fibres.

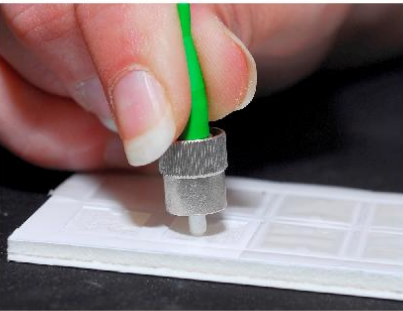

- Peel the plastic cover from an unused “N” cleaning pad.
- Hold the connector between your thumb and forefinger
- Clean the connector using firm pressure by swiping in a pendulum motion through each segment of the “N” shape, following the diagram
- Do not swipe over the same space twice.

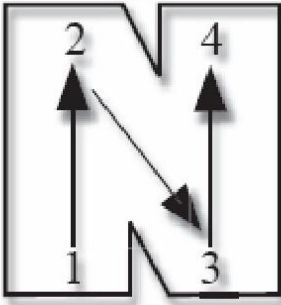

For more details please read the cleaning instruction which accompanies the connector cleaning kit.

2.2.4 Cleaning optical connectors, high levels of contamination

If there are performance issues that are not resolved by basic cleaning in section 2.2.3, then the following procedure should be used. If the level of contamination is high it will be necessary to repeat this procedure.

Cleaning items required

- Lint free fibre cleaning tissues and/or cleaning sticks (normal cosmetic tissues produce dust and are not acceptable).
- Reagent grade Isopropyl alcohol (IPA).
- Air duster or filtered compressed air line.

Cable Connector Cleaning

- Dampen a patch of cleaning tissue with IPA and clean all surfaces of the plug ferrule.
- Using a dry cleaning tissue, dry the ferrule and clean the end face.
- Using the air duster, blow away any residue from the end of the connector.

Module Female Receptacle Cleaning (only recommended if problems are being experienced)

- Either use an optical cleaning stick or twist a cleaning tissue to form a stiff probe, moisten either with IPA. Gently push the probe into the receptacle and twist around several times to dislodge any dirt.
- Repeat the above process with a dry tissue.
- Using the air duster, blow away any residue from the receptacle.

Important Notes

- IPA is flammable. Follow appropriate precautions / local guidelines when handling and storing.
- IPA can be harmful if spilt on skin. Use appropriate protection when handling.
- It should only be necessary to clean the female receptacles on the modules if problems are being experienced.



Never inspect an optical fibre or connector with the naked eye or an instrument unless you are certain that there is no optical radiation being emitted by the fibre. Remove all power sources to all modules, and completely disconnect the optical fibres.

2.2.5 FC/APC Connectors

To connect FC/APC optical connectors follow these steps:

- Remove the dust caps and align the white ceramic centre ferrule on the cable connector with the mating receptacle.
- There is a key (lug) on the side of the ferrule, which must match the keyway (gap) in the receptacle shroud.
- When they are aligned, gently push the plug home.
- Finger tighten the knurled collet nut onto the threaded receptacle.

To disconnect follow these steps:

- Using fingers fully unscrew the knurled collet nut, gently withdraw the connector.
- Replace the dust caps on both the receptacle and the cable plug.

Warning! It is possible to tighten the knurled collet without aligning the lug and gap. This will result in poor light transmission. Check that the lug and gap are aligned before tightening the knurled collet

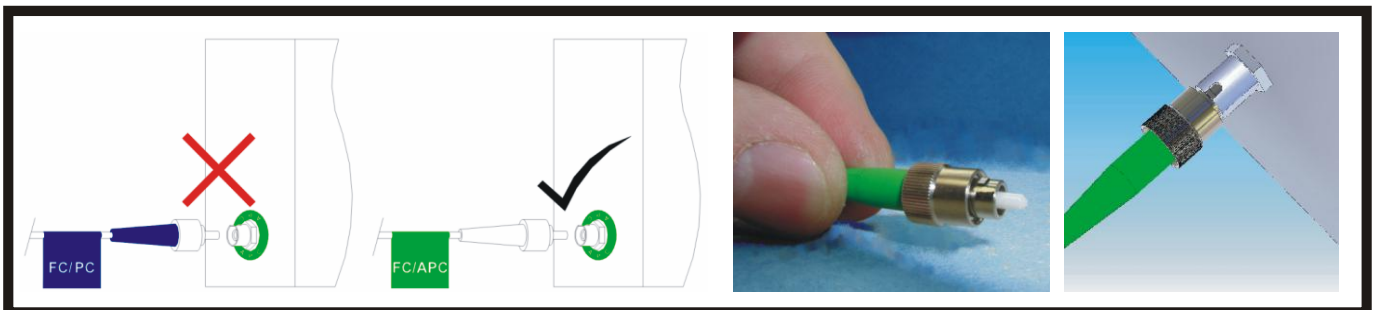

2.2.6 SC/APC Connectors

To connect SC/APC optical connectors follow these steps:

- Remove the plug protective cover.
- Align the connector keyway slot in the adaptor to the key of the plug.
- Gently push the plug-into the adapter until a click is heard and the connector locks.

To disconnect follow these steps:

- Grip the body of the plug and gently pull the plug from the adaptor, replace the protective cover.

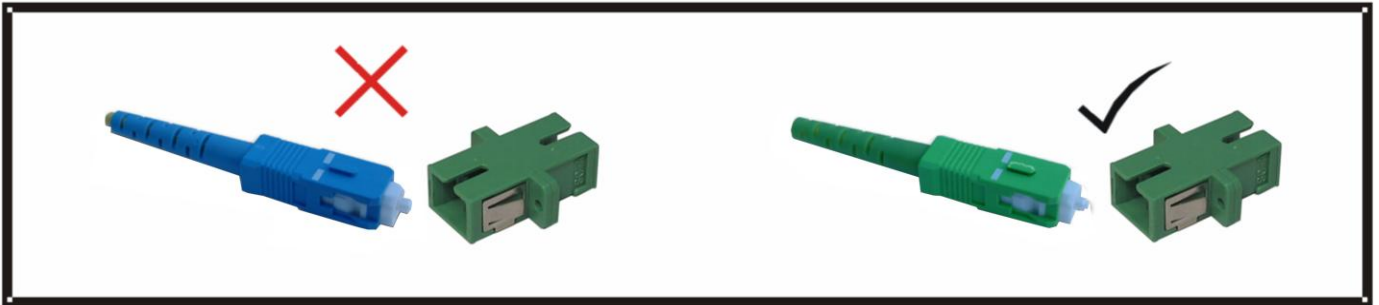

Only connect SC/APC cable to SC/APC.

2.2.7 Minimum bend radius

Because optical fibre is made of glass, it is important not to subject it to excessive stress. For this reason, each type of cable has a minimum bend radius (MBR) specification, beyond which the cable cannot be bent without permanent damage occurring.

The minimum bend radius (MBR) of fibre optic cable fitted to **ViaLiteHD** modules is 50mm.

2.3 RF Interface

2.3.1 SMA connections

The high frequency RF converters are fitted with SMA connectors. SMA connectors offer excellent performance but must be clean, free of dust and contaminants and tightened to the correct torque. Please ensure that an SMA torque spanner set to 1.0Nm is used to make the connections. An example torque wrench is shown below (Huber Suhner 74_Z-0-0-21) 1Nm 8mm/.315 inch.



Over tightening an SMA with a standard 8mm spanner will risk twisting of the connection behind the bulkhead and damage may occur that impacts the performance of the link. Always use a 1Nm torque wrench.



Connect and tighten RF connectors to present the correct termination impedance before applying power to the modules.

2.4 Front panel indicators

2.4.1 Rack plug-in modules- LEDs

Plug-in modules have three front panel LEDs for a visual indication of its state. The following table shows the operation of the front panel LEDs which are dependent on module type.

| | Colour | Plug-in Single Transmitter | Plug-in Single Receiver | Plug-in Transceiver | Plug-in Dual Transmitter | Plug-in Dual Receiver | | |
|------------|-------------------------------|--|-------------------------|---------------------|--------------------------|-----------------------|--|--|
| LED1 (PWR) | GREEN | Normal | | | | | | |
| | No light | TX PSU fail | RX PSU fail | PSU fail | PSU fail | PSU fail | | |
| LED2 (ALA) | GREEN | Normal | | | | | | |
| | RED | TX Alarm | RX Alarm | TX & RX Alarm | TX1 & TX2 Alarm | RX1 & RX2 Alarm | | |
| | RED + Pulsing ORANGE 1 PPS | N/A | N/A | TX Alarm | TX1 Alarm | RX1 Alarm | | |
| | RED + Pulsing ORANGE 2 PPS | N/A | N/A | RX Alarm | TX2 Alarm | RX2 Alarm | | |
| | Flashing RED/GREEN | Programming – Warning, do not remove power to the unit | | | | | | |
| LED3 (M&C) | GREEN | I2C enabled | | | | | | |
| | Flashing GREEN | I2C active | | | | | | |
| | ORANGE | I2C disabled | | | | | | |

2.4.2 Blue and Black OEM LED

These modules are fitted with a single status LED for indication of the state of the module. On the Blue OEM module it is placed just below the fibre connector and on the Black OEM module it is placed above and to the left of the fibre connector as shown below.

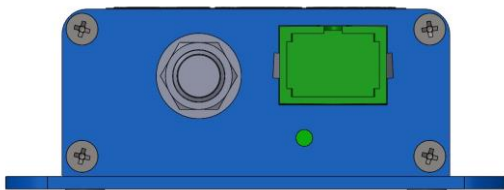

| | Colour | Blue OEM | Black OEM |
|-----|----------|----------|-----------|
| LED | GREEN | Normal | |
| | RED | Alarm | |
| | No Light | No power | |

An alarm condition on a transmitter module indicates the inability to reach target laser power.
An alarm condition on a receiver module indicates insufficient or no received light level (RLL)

2.5 I/O connections and features

2.5.1 Analogue monitors

Rack plug-in modules and Blue OEM modules have analogue monitor ports. These can be set via software to reflect either the RF or optical power level within the module. The range of the output is 0 – 2V.

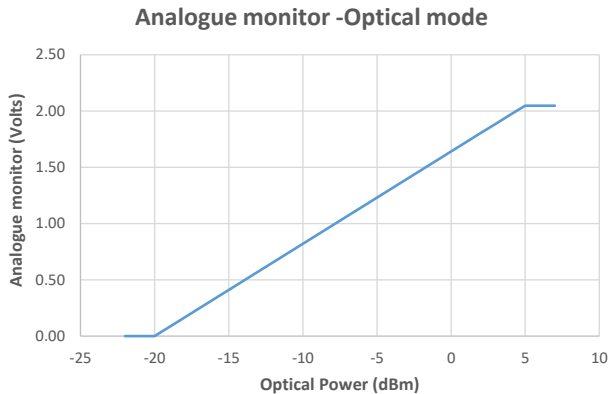

When configured to reflect optical power, 2V represents maximum rated optical power (typically 3.0mW). The analogue scale follows at -12.2dB per Volt.

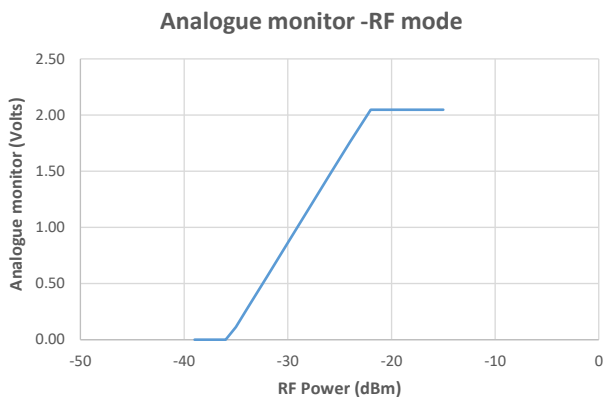

When configured to reflect RF power, 1.5V represents 10dB above the measurement noise floor. The RF detector system is for indication only as the dynamic range is fairly limited. The example given here is for a standard gain transmitter module.

2.5.2 RF Bias-T

The Blue OEM, Black OEM and Rack plug-in modules all have an integrated Bias-T for powering external amplifiers or other in-line RF devices. The Rack plug-in modules and Blue OEM modules have an option to pass in a separate user voltage for this purpose if the standard built-in options aren't suitable.

The Bias-T circuit is over-current protected and is capable of supplying up to 250mA. The Bias-T voltage and current drawn by the external device can be monitored from the USB and SNMP interfaces.

The user configurable options for the Bias-T function are as follows:

- Disabled.
No voltage is present on the RF port.
- Power supply pass-through.
The main module power supply voltage is passed on to the Bias-T.
- Internally generated 5V.
- Customer supplied independent voltage (Rack plug-in modules and Blue OEM modules only).

2.5.3 Active antenna failure detection (AFD)

The Blue OEM, Black OEM and Rack plug-in transmitter modules all have an optional AFD feature. This feature is used in conjunction with the Bias-T to monitor and remotely report the failure of an active antenna. When enabled, this feature will check that the Bias-T is supplying the correct current to an active antenna LNA. If the current falls below a user configurable threshold, the laser is disabled which causes the receive end of the link to alarm due to the lack of light. This feature is useful to quickly alert the user of a remote LNA failure which could be 10s of km away with no networked monitoring. A failed LNA could go undetected for some time depending on the nature of the received signal as the link would otherwise still function with the de-sensitised antenna.

The AFD current threshold can be user configured from between 2mA and 200mA.

2.5.4 Alarm voltage

The Blue OEM and Rack plug-in modules have a pin on the I/O for external alarm monitoring. This can be used for fast hardware switching of redundant links for example. The interface is open-drain and will float in the event of an alarm to enable pull up to the user side voltage.

2.5.5 Blue OEM 10 pin user connector

The Blue OEM module is equipped with a 10-pin user accessible port for further integration capability. The pin identification and function is shown below.

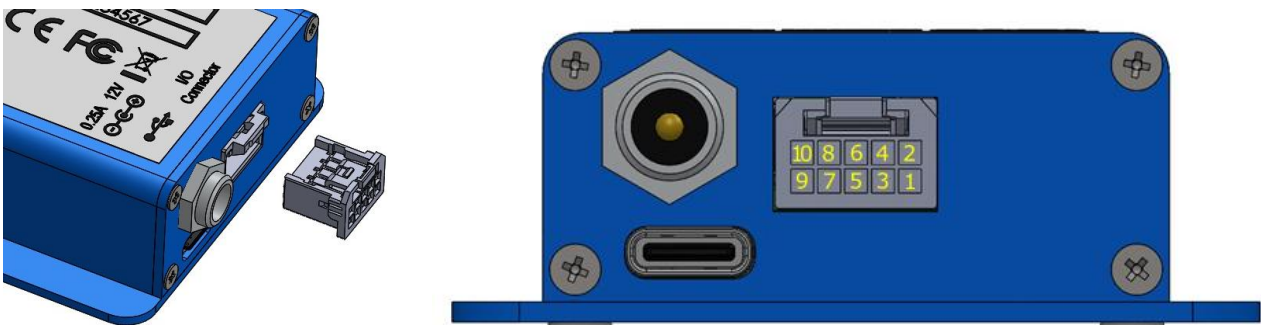

| Pin Number | Name | Function |
|------------|----------|---|
| 1 | GND | Ground connection |
| 2 | Vin | 12V Power in (9-18V) (Alternative to 2.1mm Jack) |
| 3 | N/C | UNUSED |
| 4 | Ext_Bias | User supplied RF port Bias-T voltage (SW enabled) |
| 5 | N/C | UNUSED |
| 6 | LEV_MON1 | Analogue level monitor (RF or optical power) |
| 7 | GND | Ground connection |
| 8 | N/C | UNUSED |
| 9 | SCL | I2C control clock |
| 10 | SDA | I2C control data |

The Blue OEM module is supplied with the mating connector and 25cm tails (part number 73953). The connector and crimps are Molex 501646-1000 and 501647-1000 respectively should a user wish to derive their own application.

2.5.6 Receiver RLL AGC function

It is often desirable to have a constant RF over fibre analogue end-to-end link gain despite small changes in optical path loss. With the AGC RLL function enabled, changes in optical Received Light Level (RLL) are counteracted with corresponding changes in RF gain. The end result is a consistent RF link gain regardless of optical path loss. It should be noted however that when using AGC RLL, the following points apply:

- RF Gain changes are in 0.5dB steps.
- Hysteresis is applied to prevent gain oscillations.
- An AGC gain target is required to be set for nominal RLL.
- RF Gain control range is limited to 15.5dB.
RF Gain will limit at its maximum when RLL is very low compared to nominal.
RF Gain will limit at its minimum when RLL is very high compared to nominal.

Typical usage scenarios are as follows:

- Switched optical path systems.
- Long distance link with fibre path loss fluctuations due to fibre temperature changes or strain.
- Link system over rented network suffering regular maintenance and reconfiguration.

2.6 Dual Rack plug-in modules

The Rack plug-in modules supports dual channel configurations and the following rear panel connection arrangements apply.

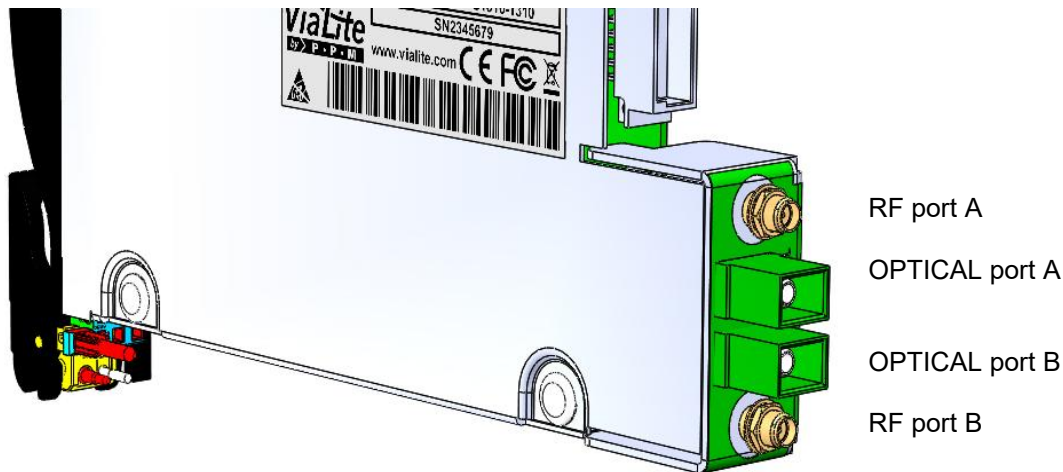

| Port set | Dual TX | Dual RX | Transceiver |
|----------|---------------|------------|-------------|
| A | Transmitter 1 | Receiver 1 | Receiver |
| B | Transmitter 2 | Receiver 2 | Transmitter |

2.7 USB CLI command and control

The Blue OEM and Black OEM modules can be supplied with a USB-C cable (55058) which when plugged into a PC, registers as a serial COM port. This then delivers a command line interface (CLI) over a terminal application. There are many terminal applications available, below is an example using the open-source PuTTY application.

<https://www.putty.org/>



A rubber bung is used to seal the USB-C socket on the Black OEM modules which needs to be removed to allow connection. This is a screw in bung and needs to be turned anti-clockwise to remove. Ensure the bung is refitted and fully tightened when programming is finished before putting into service.

2.7.1 Connection configuration

The connection parameters are, as is fairly common:
 9600 baud, 8 Data bits, 1 Stop bit, with no parity or flow control. Local echo ON.

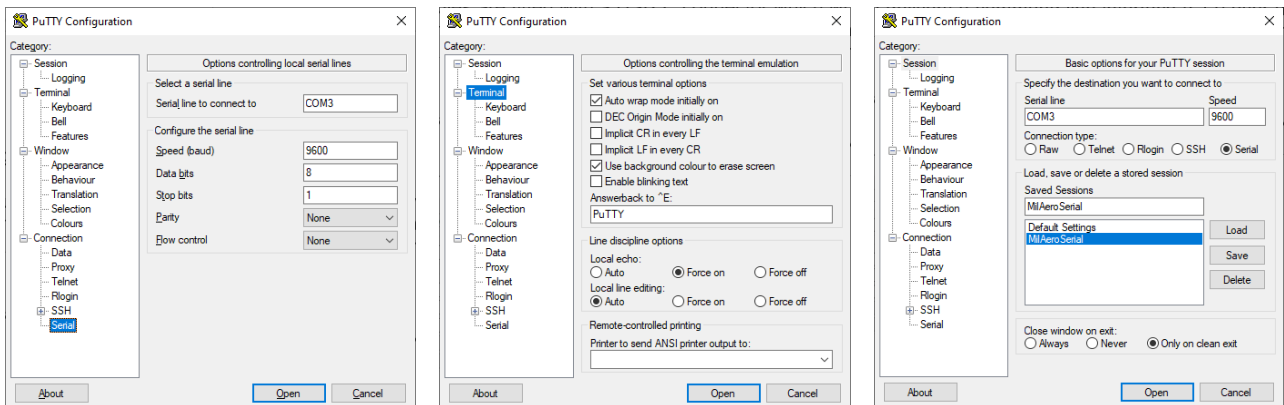

2.7.2 Command set

User control of the various link settings can be accessed via a USB port on both the Blue OEM and Black OEM modules. When connected to a PC, the USB will render itself as a COM port on the system and can be addressed via a terminal application such as TeraTerm or PuTTY. The **ViaLiteHD** 6 GHz link – SCPI – commands user guide [here](#) outlines the command set that can be used over the terminal application.

2.8 Rack plug-in modules web interface

The Rack plug-in modules can be monitored and controlled via a **ViaLiteHD** System Monitoring & Control Module (HRC-3), web GUI and by SNMP over the Ethernet interface supported in the **ViaLiteHD** chassis (HRK).

Below is a screenshot of the web GUI for a dual transmitter.



Name: Location: Contact: User: Technician

System
Management
Reports
Update
Help
Log out

HRK3S Status



Visual Display

Module 11 - 6GHz Dual Transmitter

Bias-T Voltage: 1.49 V

Bias-T Current: 0 mA

SGC Range: -6.5 - 9.0 dB

Control

Transmitter A

SGC Enable:

Factory Default RF Gain: 6.00 dB

SGC Target (dB):

Bias-T Source:

Transmitter B

SGC Enable:

Factory Default RF Gain: 5.00 dB

SGC Target (dB):

Bias-T Source:

10Mhz-6Ghz Link

Refresh
Apply
Close

Event Log

16:12:41 12/02/20
View: MORE | LESS
Generate Events Report

Search:

| Index | Time/Date | System Uptime | Event | Slot | Module Type | Severity |
|-------|-------------------|---------------|----------------|------|-----------------------|----------|
| 2734 | 16:09:11 12/02/20 | 2h 15m 0s | RF Level Alarm | 11 | 6GHz Dual Transmitter | Minor |

3 System integration

In order to integrate the link into a communication system, a full understanding of its performance is required. This section will detail the various performance aspects and how they are affected by optical link length and environmental effects such as temperature.

3.1 Link gain

The link gain is a combination of the transmitter gain, fibre loss and receiver gain. The transmitter and receiver have gain controls to optimise performance when integrated with external user equipment.

3.1.1 Transmitter gain

The transmitter gain setting directly influences the Link noise figure and linearity so is used to optimise the interface to the user signal source. There is 15dB of gain control available around the nominal default gain delivered by the hardware.

The transmitter module is available in various gain versions to suit different markets. Higher gain versions have extra amplifiers integrated and have a slightly higher power consumption as a result.

3.1.2 Fibre loss

The optical loss through the fibre and any other optical distribution components has a significant effect on the performance of the link. The link end-to-end RF gain will drop 2dB for every 1dB of optical loss. It is therefore crucial to ensure optical losses are minimised.

A well mated optical connection will give about 0.2dB of optical insertion loss so minimising the number of connections is crucial. Wherever possible in the optical network, replace connections with splices to minimise loss. All **ViaLiteHD** links are calibrated inclusive of their own connection loss so these don't need to be accounted for in user designs, only any additional connections.

| Optical Characteristics | | |
|-------------------------|--------------|--------------|
| Attenuation | Maximum | Typical |
| at 1310 nm | ≤ 0.34 dB/km | ≤ 0.33 dB/km |
| at 1385 nm | ≤ 0.31 dB/km | ≤ 0.27 dB/km |
| at 1490 nm | ≤ 0.24 dB/km | ≤ 0.21 dB/km |
| at 1550 nm | ≤ 0.21 dB/km | ≤ 0.19 dB/km |
| at 1625 nm | ≤ 0.24 dB/km | ≤ 0.20 dB/km |

For long distance links, care must be taken when selecting the transmitter laser wavelength. Standard SMF28 optical fibre has a different loss profile per wavelength. The data here is an example ZWP fibre from OFS.

Significant optical losses can also be created by stretching or bending optical fibre beyond its minimum bend radius. Ensure the minimum bend radius is adhered to for the choice of single mode fibre in use.

3.1.3 Receiver gain

The receiver gain setting has only a very minor influence on link noise figure and linearity and is used mainly to adjust the link output level to optimise the interface to the user signal sink equipment. There is 15dB of gain control available around the nominal default gain delivered by the hardware.

3.1.4 Gain selection for optimum link performance

The following guide shows how to trade NF and Linearity using the transmitter gain control and link output power using the receiver gain control for optimal interfacing with user equipment.

The various link configurations are shown in rows with reference data at both 1.5 GHz and 5 GHz.

| 10MHz-6GHz RFoF: Unity link 1.5 GHz | | | | | | | | | | | | 10MHz-6GHz RFoF: Unity link 5 GHz | | | | | | | | | | | | | | |
|-------------------------------------|-------|-------|-------|-------|-------|-------|-------|-------|-------|-------|-------|-----------------------------------|---------------------------|-------|-------|-------|-------|-------|-------|-------|-------|-------|-------|-------|-----|---------------------------|
| SFDR | 109.3 | 109.5 | 109.7 | 109.8 | 109.9 | 110.0 | 110.0 | 110.1 | 110.1 | 110.1 | 110.1 | dB/Hz | SFDR | 102.1 | 102.2 | 102.3 | 102.4 | 102.4 | 102.5 | 102.5 | 102.5 | 102.6 | 102.6 | dB/Hz | | |
| IP1 | 3.7 | 3.0 | 2.3 | 1.5 | 0.7 | -0.1 | -1.0 | -1.9 | -2.8 | -3.7 | -4.6 | dBm | IP1 | 2.6 | 2.0 | 1.3 | 0.5 | -0.3 | -1.1 | -2.0 | -2.8 | -3.7 | -4.7 | -5.6 | dBm | |
| IIP3 | 15.0 | 14.3 | 13.5 | 12.7 | 11.9 | 11.0 | 10.2 | 9.3 | 8.3 | 7.4 | 6.4 | dBm | IIP3 | 11.4 | 10.6 | 9.7 | 8.8 | 7.9 | 7.0 | 6.0 | 5.1 | 4.1 | 3.1 | 2.1 | dBm | |
| NF | 24.9 | 23.9 | 22.9 | 21.9 | 20.9 | 20.0 | 19.0 | 18.0 | 17.1 | 16.1 | 15.2 | dB | NF | 32.1 | 31.1 | 30.1 | 29.1 | 28.1 | 27.1 | 26.1 | 25.1 | 24.1 | 23.1 | 22.2 | dB | |
| TX Gain (dB) | -15 | -14 | -13 | -12 | -11 | -10 | -9 | -8 | -7 | -6 | -5 | | TX Gain (dB) | -15 | -14 | -13 | -12 | -11 | -10 | -9 | -8 | -7 | -6 | -5 | | |
| Nominal RX Gain (dB) | 9 | -6 | -5 | -4 | -3 | -2 | -1 | 0 | 1 | 2 | 3 | 4 | Available link gains (dB) | 9 | -6 | -5 | -4 | -3 | -2 | -1 | 0 | 1 | 2 | 3 | 4 | Available link gains (dB) |
| | 10 | -5 | -4 | -3 | -2 | -1 | 0 | 1 | 2 | 3 | 4 | 5 | | 10 | -5 | -4 | -3 | -2 | -1 | 0 | 1 | 2 | 3 | 4 | 5 | |
| | 11 | -4 | -3 | -2 | -1 | 0 | 1 | 2 | 3 | 4 | 5 | 6 | | 11 | -4 | -3 | -2 | -1 | 0 | 1 | 2 | 3 | 4 | 5 | 6 | |
| | 12 | -3 | -2 | -1 | 0 | 1 | 2 | 3 | 4 | 5 | 6 | 7 | | 12 | -3 | -2 | -1 | 0 | 1 | 2 | 3 | 4 | 5 | 6 | 7 | |
| | 13 | -2 | -1 | 0 | 1 | 2 | 3 | 4 | 5 | 6 | 7 | 8 | | 13 | -2 | -1 | 0 | 1 | 2 | 3 | 4 | 5 | 6 | 7 | 8 | |
| | 14 | -1 | 0 | 1 | 2 | 3 | 4 | 5 | 6 | 7 | 8 | 9 | | 14 | -1 | 0 | 1 | 2 | 3 | 4 | 5 | 6 | 7 | 8 | 9 | |
| | 15 | 0 | 1 | 2 | 3 | 4 | 5 | 6 | 7 | 8 | 9 | 10 | | 15 | 0 | 1 | 2 | 3 | 4 | 5 | 6 | 7 | 8 | 9 | 10 | |
| | 16 | 1 | 2 | 3 | 4 | 5 | 6 | 7 | 8 | 9 | 10 | 11 | | 16 | 1 | 2 | 3 | 4 | 5 | 6 | 7 | 8 | 9 | 10 | 11 | |
| | 17 | 2 | 3 | 4 | 5 | 6 | 7 | 8 | 9 | 10 | 11 | 12 | | 17 | 2 | 3 | 4 | 5 | 6 | 7 | 8 | 9 | 10 | 11 | 12 | |
| | 18 | 3 | 4 | 5 | 6 | 7 | 8 | 9 | 10 | 11 | 12 | 13 | | 18 | 3 | 4 | 5 | 6 | 7 | 8 | 9 | 10 | 11 | 12 | 13 | |
| | 19 | 4 | 5 | 6 | 7 | 8 | 9 | 10 | 11 | 12 | 13 | 14 | | 19 | 4 | 5 | 6 | 7 | 8 | 9 | 10 | 11 | 12 | 13 | 14 | |
| | 20 | 5 | 6 | 7 | 8 | 9 | 10 | 11 | 12 | 13 | 14 | 15 | | 20 | 5 | 6 | 7 | 8 | 9 | 10 | 11 | 12 | 13 | 14 | 15 | |
| 21 | 6 | 7 | 8 | 9 | 10 | 11 | 12 | 13 | 14 | 15 | 16 | 21 | 6 | 7 | 8 | 9 | 10 | 11 | 12 | 13 | 14 | 15 | 16 | | | |
| 22 | 7 | 8 | 9 | 10 | 11 | 12 | 13 | 14 | 15 | 16 | 17 | 22 | 7 | 8 | 9 | 10 | 11 | 12 | 13 | 14 | 15 | 16 | 17 | | | |

| 10MHz-6GHz RFoF: High Gain link 1.5 GHz | | | | | | | | | | | | 10MHz-6GHz RFoF: High Gain link 5 GHz | | | | | | | | | | | | | | |
|---|-------|-------|-------|-------|-------|-------|-------|-------|-------|-------|-------|---------------------------------------|---------------------------|-------|-------|-------|-------|-------|-------|-------|-------|-------|-------|-------|-------|---------------------------|
| SFDR | 107.6 | 107.8 | 108.0 | 108.0 | 107.9 | 107.8 | 107.5 | 107.3 | 106.9 | 106.5 | | dB/Hz | SFDR | 101.4 | 101.5 | 101.7 | 101.8 | 101.9 | 102.0 | 102.0 | 101.9 | 101.9 | 101.8 | 101.8 | dB/Hz | |
| IP1 | -10.9 | -11.5 | -12.2 | -12.9 | -13.7 | -14.5 | -15.3 | -16.2 | -17.0 | -18.0 | -18.9 | dBm | IP1 | -11.8 | -12.4 | -13.0 | -13.7 | -14.4 | -15.1 | -15.9 | -16.8 | -17.6 | -18.5 | -19.4 | dBm | |
| IIP3 | -0.8 | -1.3 | -1.9 | -2.5 | -3.2 | -3.9 | -4.6 | -5.4 | -6.3 | -7.1 | -8.0 | dBm | IIP3 | -3.3 | -4.0 | -4.7 | -5.5 | -6.3 | -7.1 | -8.0 | -8.9 | -9.8 | -10.7 | -11.7 | dBm | |
| NF | 11.6 | 10.8 | 10.1 | 9.4 | 8.7 | 8.1 | 7.6 | 7.1 | 6.7 | 6.3 | 6.0 | dB | NF | 18.5 | 17.6 | 16.6 | 15.6 | 14.7 | 13.8 | 12.9 | 12.0 | 11.1 | 10.3 | 9.5 | dB | |
| TX Gain (dB) | -1 | 0 | 1 | 2 | 3 | 4 | 5 | 6 | 7 | 8 | 9 | | TX Gain (dB) | -1 | 0 | 1 | 2 | 3 | 4 | 5 | 6 | 7 | 8 | 9 | | |
| Nominal RX Gain (dB) | 9 | 8 | 9 | 10 | 11 | 12 | 13 | 14 | 15 | 16 | 17 | 18 | Available link gains (dB) | 9 | 8 | 9 | 10 | 11 | 12 | 13 | 14 | 15 | 16 | 17 | 18 | Available link gains (dB) |
| | 10 | 9 | 10 | 11 | 12 | 13 | 14 | 15 | 16 | 17 | 18 | 19 | | 10 | 9 | 10 | 11 | 12 | 13 | 14 | 15 | 16 | 17 | 18 | 19 | |
| | 11 | 10 | 11 | 12 | 13 | 14 | 15 | 16 | 17 | 18 | 19 | 20 | | 11 | 10 | 11 | 12 | 13 | 14 | 15 | 16 | 17 | 18 | 19 | 20 | |
| | 12 | 11 | 12 | 13 | 14 | 15 | 16 | 17 | 18 | 19 | 20 | 21 | | 12 | 11 | 12 | 13 | 14 | 15 | 16 | 17 | 18 | 19 | 20 | 21 | |
| | 13 | 12 | 13 | 14 | 15 | 16 | 17 | 18 | 19 | 20 | 21 | 22 | | 13 | 12 | 13 | 14 | 15 | 16 | 17 | 18 | 19 | 20 | 21 | 22 | |
| | 14 | 13 | 14 | 15 | 16 | 17 | 18 | 19 | 20 | 21 | 22 | 23 | | 14 | 13 | 14 | 15 | 16 | 17 | 18 | 19 | 20 | 21 | 22 | 23 | |
| | 15 | 14 | 15 | 16 | 17 | 18 | 19 | 20 | 21 | 22 | 23 | 24 | | 15 | 14 | 15 | 16 | 17 | 18 | 19 | 20 | 21 | 22 | 23 | 24 | |
| | 16 | 15 | 16 | 17 | 18 | 19 | 20 | 21 | 22 | 23 | 24 | 25 | | 16 | 15 | 16 | 17 | 18 | 19 | 20 | 21 | 22 | 23 | 24 | 25 | |
| | 17 | 16 | 17 | 18 | 19 | 20 | 21 | 22 | 23 | 24 | 25 | 26 | | 17 | 16 | 17 | 18 | 19 | 20 | 21 | 22 | 23 | 24 | 25 | 26 | |
| | 18 | 17 | 18 | 19 | 20 | 21 | 22 | 23 | 24 | 25 | 26 | 27 | | 18 | 17 | 18 | 19 | 20 | 21 | 22 | 23 | 24 | 25 | 26 | 27 | |
| | 19 | 18 | 19 | 20 | 21 | 22 | 23 | 24 | 25 | 26 | 27 | 28 | | 19 | 18 | 19 | 20 | 21 | 22 | 23 | 24 | 25 | 26 | 27 | 28 | |
| | 20 | 19 | 20 | 21 | 22 | 23 | 24 | 25 | 26 | 27 | 28 | 29 | | 20 | 19 | 20 | 21 | 22 | 23 | 24 | 25 | 26 | 27 | 28 | 29 | |
| 21 | 20 | 21 | 22 | 23 | 24 | 25 | 26 | 27 | 28 | 29 | 30 | 21 | 20 | 21 | 22 | 23 | 24 | 25 | 26 | 27 | 28 | 29 | 30 | | | |
| 22 | 21 | 22 | 23 | 24 | 25 | 26 | 27 | 28 | 29 | 30 | 31 | 22 | 21 | 22 | 23 | 24 | 25 | 26 | 27 | 28 | 29 | 30 | 31 | | | |

| 10MHz-6GHz RFoF: High Output link 1.5 GHz | | | | | | | | | | | | 10MHz-6GHz RFoF: High Output link 5 GHz | | | | | | | | | | | | | | |
|---|-------|-------|-------|-------|-------|-------|-------|-------|-------|-------|-------|---|---------------------------|-------|-------|-------|-------|-------|-------|-------|-------|-------|-------|-------|-------|---------------------------|
| SFDR | 109.4 | 109.5 | 109.7 | 109.8 | 109.9 | 109.9 | 110.0 | 110.0 | 110.0 | 110.0 | 110.0 | dB/Hz | SFDR | 102.0 | 102.1 | 102.2 | 102.3 | 102.3 | 102.3 | 102.4 | 102.4 | 102.4 | 102.4 | 102.4 | dB/Hz | |
| IP1 | 3.3 | 2.7 | 1.9 | 1.1 | 0.3 | -0.5 | -1.4 | -2.3 | -3.2 | -4.2 | -5.1 | dBm | IP1 | 2.3 | 1.6 | 0.9 | 0.1 | -0.7 | -1.5 | -2.4 | -3.3 | -4.2 | -5.1 | -6.1 | dBm | |
| IIP3 | 14.7 | 13.9 | 13.1 | 12.3 | 11.5 | 10.6 | 9.7 | 8.8 | 7.9 | 6.9 | 6.0 | dBm | IIP3 | 11.2 | 10.4 | 9.5 | 8.6 | 7.7 | 6.7 | 5.8 | 4.8 | 3.9 | 2.9 | 1.9 | dBm | |
| NF | 24.5 | 23.5 | 22.5 | 21.5 | 20.6 | 19.6 | 18.6 | 17.7 | 16.7 | 15.8 | 14.8 | dB | NF | 32.1 | 31.1 | 30.1 | 29.1 | 28.1 | 27.1 | 26.1 | 25.1 | 24.1 | 23.1 | 22.1 | dB | |
| TX Gain (dB) | -15 | -14 | -13 | -12 | -11 | -10 | -9 | -8 | -7 | -6 | -5 | | TX Gain (dB) | -15 | -14 | -13 | -12 | -11 | -10 | -9 | -8 | -7 | -6 | -5 | | |
| Nominal RX Gain (dB) | 15 | 0 | 1 | 2 | 3 | 4 | 5 | 6 | 7 | 8 | 9 | 10 | Available link gains (dB) | 15 | 0 | 1 | 2 | 3 | 4 | 5 | 6 | 7 | 8 | 9 | 10 | Available link gains (dB) |
| | 16 | 1 | 2 | 3 | 4 | 5 | 6 | 7 | 8 | 9 | 10 | 11 | | 16 | 1 | 2 | 3 | 4 | 5 | 6 | 7 | 8 | 9 | 10 | 11 | |
| | 17 | 2 | 3 | 4 | 5 | 6 | 7 | 8 | 9 | 10 | 11 | 12 | | 17 | 2 | 3 | 4 | 5 | 6 | 7 | 8 | 9 | 10 | 11 | 12 | |
| | 18 | 3 | 4 | 5 | 6 | 7 | 8 | 9 | 10 | 11 | 12 | 13 | | 18 | 3 | 4 | 5 | 6 | 7 | 8 | 9 | 10 | 11 | 12 | 13 | |
| | 19 | 4 | 5 | 6 | 7 | 8 | 9 | 10 | 11 | 12 | 13 | 14 | | 19 | 4 | 5 | 6 | 7 | 8 | 9 | 10 | 11 | 12 | 13 | 14 | |
| | 20 | 5 | 6 | 7 | 8 | 9 | 10 | 11 | 12 | 13 | 14 | 15 | | 20 | 5 | 6 | 7 | 8 | 9 | 10 | 11 | 12 | 13 | 14 | 15 | |
| | 21 | 6 | 7 | 8 | 9 | 10 | 11 | 12 | 13 | 14 | 15 | 16 | | 21 | 6 | 7 | 8 | 9 | 10 | 11 | 12 | 13 | 14 | 15 | 16 | |
| | 22 | 7 | 8 | 9 | 10 | 11 | 12 | 13 | 14 | 15 | 16 | 17 | | 22 | 7 | 8 | 9 | 10 | 11 | 12 | 13 | 14 | 15 | 16 | 17 | |
| | 23 | 8 | 9 | 10 | 11 | 12 | 13 | 14 | 15 | 16 | 17 | 18 | | 23 | 8 | 9 | 10 | 11 | 12 | 13 | 14 | 15 | 16 | 17 | 18 | |
| | 24 | 9 | 10 | 11 | 12 | 13 | 14 | 15 | 16 | 17 | 18 | 19 | | 24 | 9 | 10 | 11 | 12 | 13 | 14 | 15 | 16 | 17 | 18 | 19 | |
| | 25 | 10 | 11 | 12 | 13 | 14 | 15 | 16 | 17 | 18 | 19 | 20 | | 25 | 10 | 11 | 12 | 13 | 14 | 15 | 16 | 17 | 18 | 19 | 20 | |
| | 26 | 11 | 12 | 13 | 14 | 15 | 16 | 17 | 18 | 19 | 20 | 21 | | 26 | 11 | 12 | 13 | 14 | 15 | 16 | 17 | 18 | 19 | 20 | 21 | |
| 27 | 12 | 13 | 14 | 15 | 16 | 17 | 18 | 19 | 20 | 21 | 22 | 27 | 12 | 13 | 14 | 15 | 16 | 17 | 18 | 19 | 20 | 21 | 22 | | | |
| 28 | 13 | 14 | 15 | 16 | 17 | 18 | 19 | 20 | 21 | 22 | 23 | 28 | 13 | 14 | 15 | 16 | 17 | 18 | 19 | 20 | 21 | 22 | 23 | | | |

3.2 Frequency response

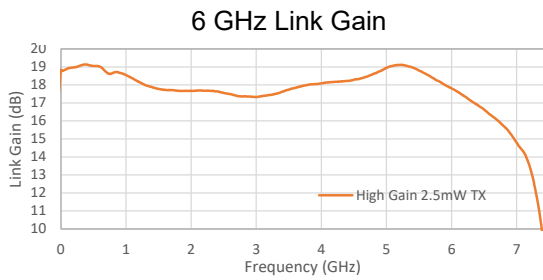

The link frequency response is fairly flat from 10 MHz to 6GHz typically < +/- 1 dB. Usable gain is present up to 7GHz.

3.3 VSWR

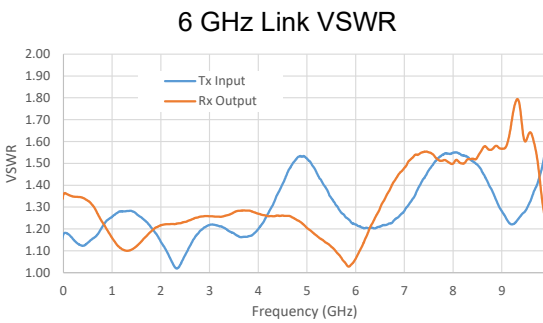

The VSWR of the transmitter input and receiver output is generally better than 1.4.

3.4 Noise Figure

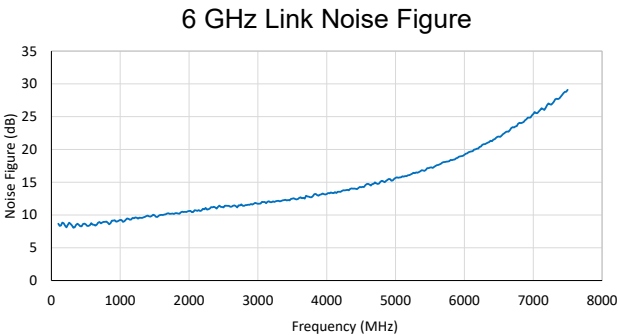

The Noise figure can be traded with linearity using the transmitter gain settings to best suit the application. The measurement here is from a link incorporating the high gain transmitter. The noise figure of the link increases with frequency as a result of the laser technology so must be considered when selecting the gain.

3.4.1 Noise figure vs link loss

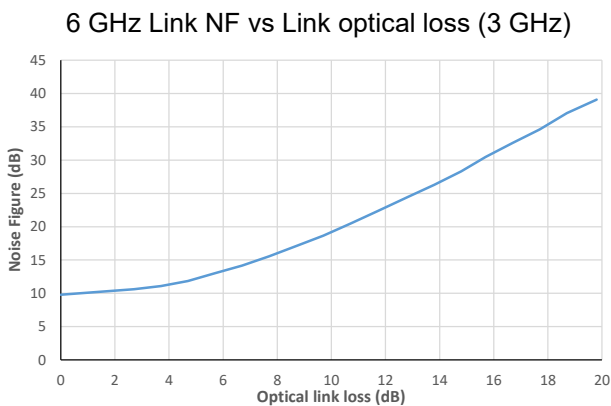

The Noise figure degrades with increasing link loss. In the high gain link measurement shown adjacent, the noise figure increases slowly for the first 4-5 dB of optical loss and then increases 2:1 with optical loss. Minimising link loss is crucial to maintain best performance.

3.5 P1dB Compression

ViaLiteHD Link: Compression input P1dB

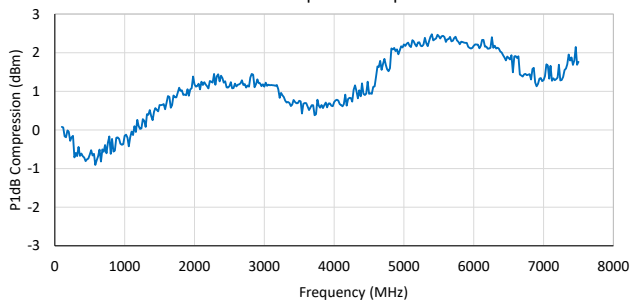

The input P1dB compression point of the link is fairly consistent with frequency and is directly influenced by the transmitter gain setting which can be traded with noise figure to suit the application. The measurement here is from a link incorporating the low gain transmitter. This parameter does not change with link loss though it does change with link length if presented with chromatic dispersion. Please consult your sales representative for long distance designs that mitigate for dispersion effects.

3.6 IP3 Linearity

ViaLiteHD Link: IIP3

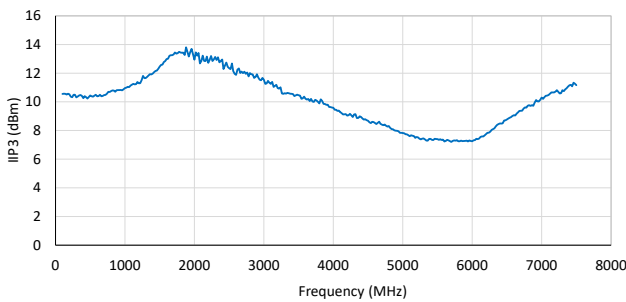

The input IP3 of the link is fairly consistent with frequency and is directly influenced by the transmitter gain setting which can be traded with noise figure to suit the application. The measurement here is from a link incorporating the low gain transmitter. This parameter does not change with link loss though it does change with link length if presented with chromatic dispersion. Please consult your sales representative for long distance designs that mitigate for dispersion effects.

3.7 Spurious Free Dynamic Range (SFDR)

6 GHz Link SFDR

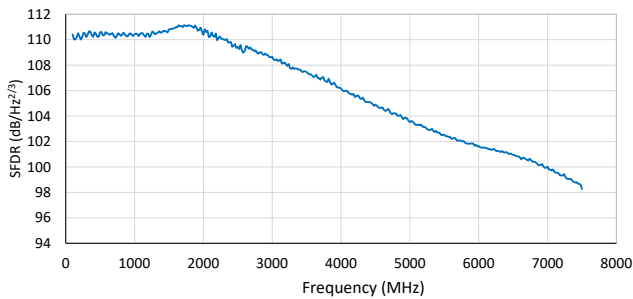

The SFDR of the link is a result of the noise figure and IP3 and is a good indicator of link dynamic range. This is important for links that transport wideband signals or signals with complex modulation types. The roll-off with frequency follows the noise figure response as stated earlier.

3.7.1 SFDR vs link loss

6 GHz Link SFDR vs Link optical loss (3 GHz)

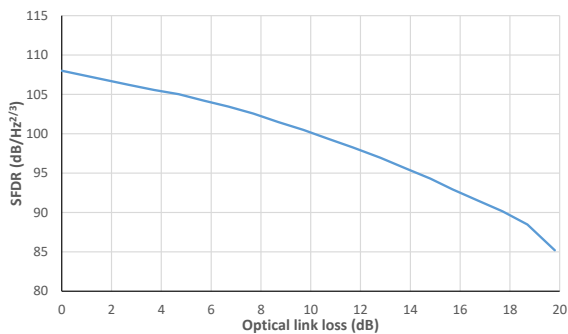

The SFDR degrades with link loss as a result of the increasing noise figure. Further degradation with link length can be expected if presented with chromatic dispersion. Please consult your sales representative for long distance designs that mitigate for dispersion effects.

3.8 Link delay

6 GHz Link Delay

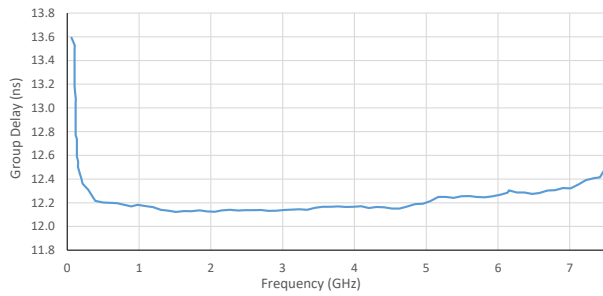

The delay through a short link (1m) is fairly consistent from 240 MHz to 6 GHz at 12.2ns. The extra delay seen in the link for low frequencies (<240 MHz) is visible in the measurement data and is a feature of the optics and interface circuits that can't be avoided, though for any real-life fibre length, this difference becomes negligible at the equivalent of only 6m of fibre for the 40ns measured at 10 MHz.

3.9 Deviation from linear phase

6 GHz High Gain Link: Deviation from Linear phase

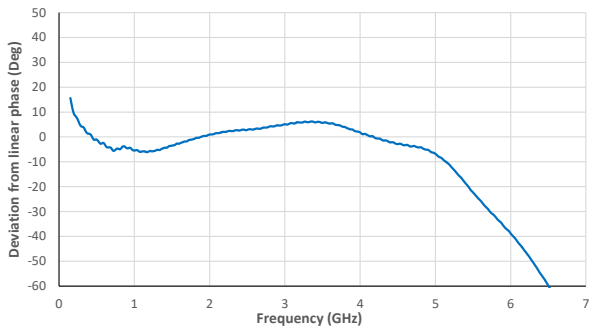

The deviation from linear phase is within +/- 7 degrees from 350MHz to 5GHz. At the frequency extremes, the phase deviates as shown in the chart.

4 Mechanical details

4.1 Blue OEM module dimensions

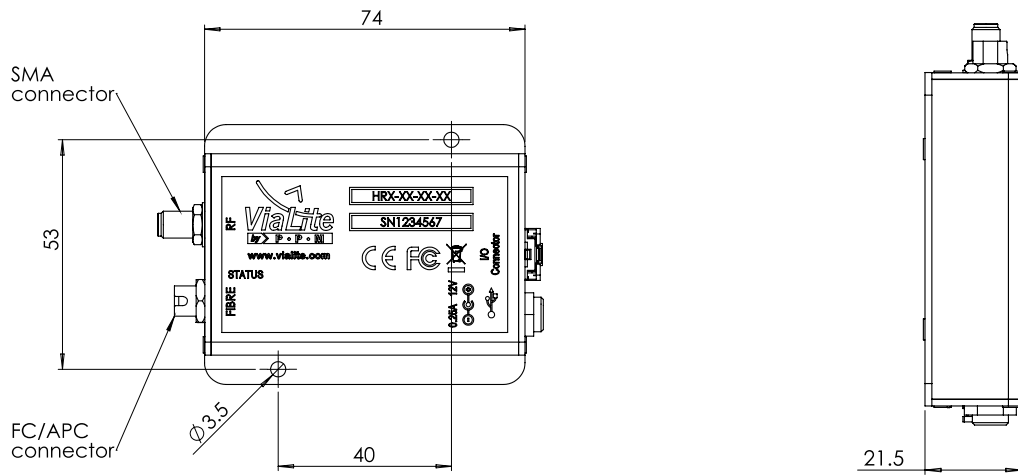

4.2 Blue OEM connector positions

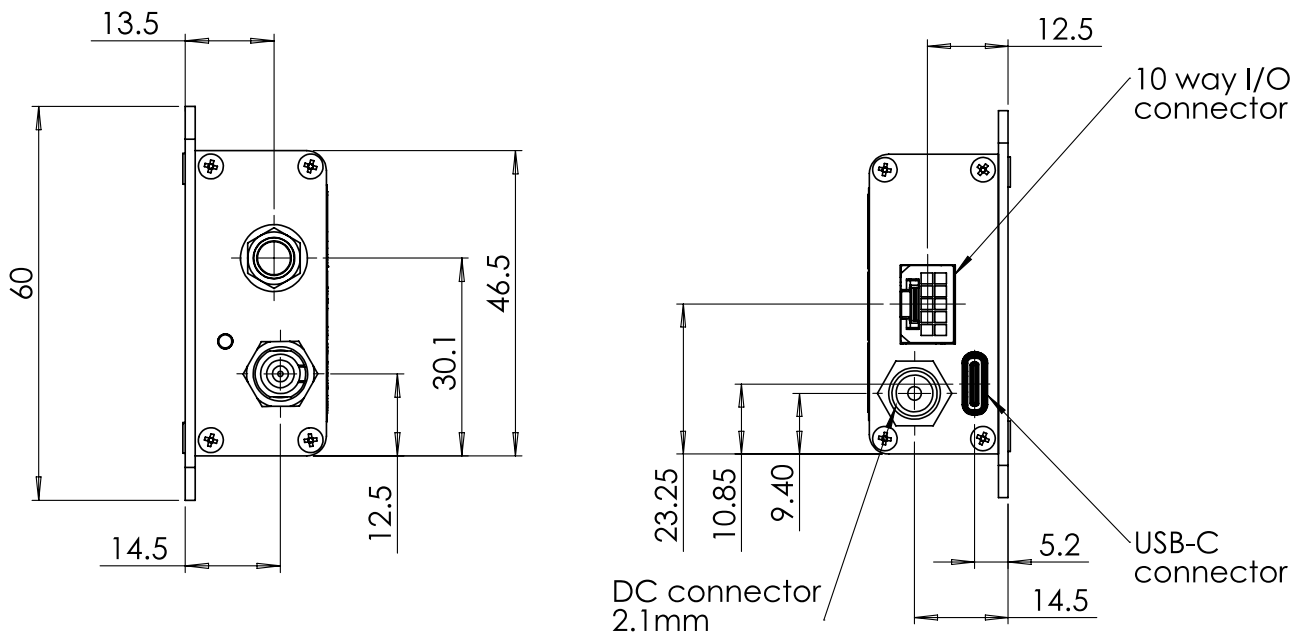

4.3 **Black OEM module dimensions**

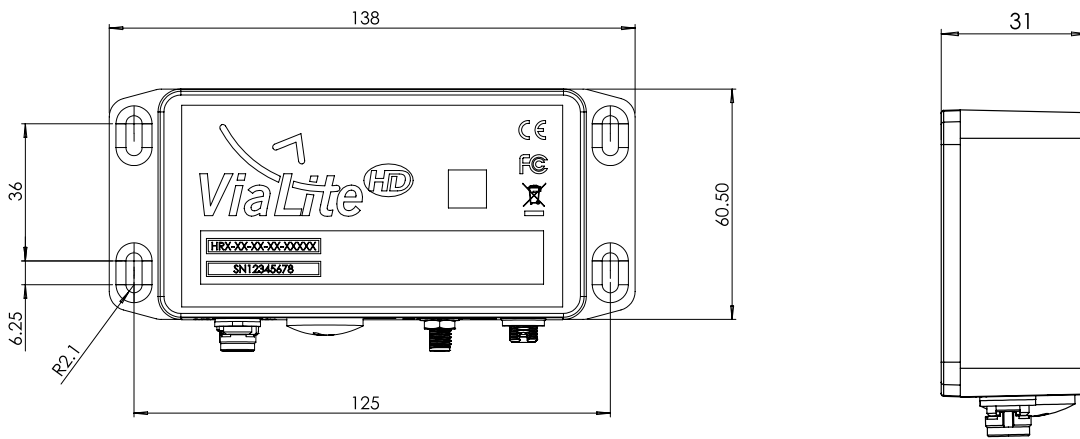

4.4 **Black OEM connector positions**

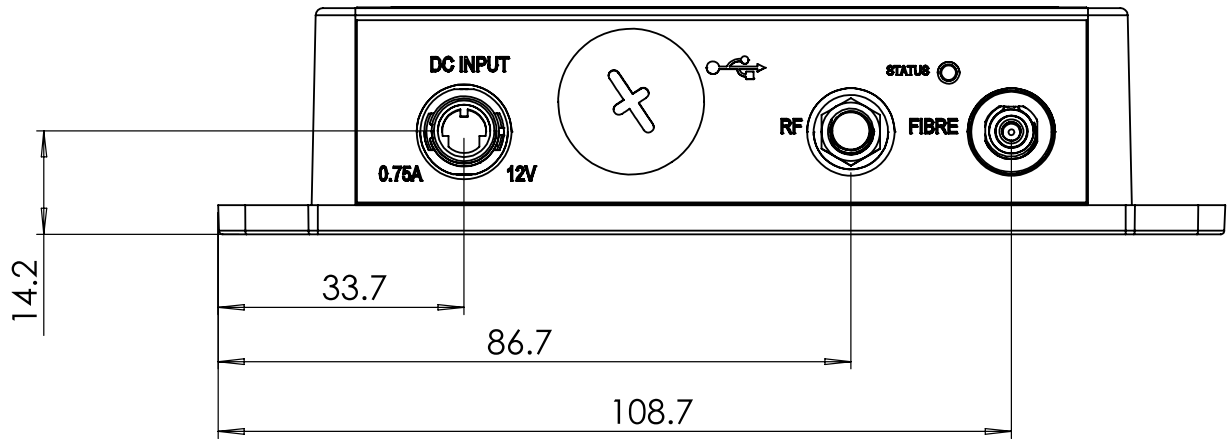

5 Part numbering

For part numbering please refer to the relevant datasheet which can be found on our website or contact us.

6 Technical specifications

| | Standard Gain Link HRT-Y1-xx-04-C1310 HRR-Y1-xx-05 | High Gain Link HRT-Y1-xx-01-C1310 HRR-Y1-xx-05 | High Output Link HRT-Y1-xx-04-C1310 HRR-Y1-xx-03 |
|---|--|---|---|
| Frequency (Typ.) | 10 MHz to 6 GHz | 10 MHz to 6 GHz | 10 MHz to 6 GHz |
| Input P1dB (Typ. @ 1500 MHz) | 0 dBm | -15 dBm | 0 dBm |
| IP3 (Typ. @ 1500MHz) | 10 dBm | -5 dBm | 10 dBm |
| Gain Slope | <-0.35 dB / GHz | <-0.35 dB / GHz | <-0.40 dB / GHz |
| Gain Ripple | < +/-1 dB | < +/-1 dB | < +/-1.2 dB |
| Gain Adjustment from Nominal | +5 dB to -9.5 dB 0.5 dB attenuation steps | +5 dB to -9.5 dB 0.5 dB attenuation steps | +5 dB to -9.5 dB 0.5 dB attenuation steps |
| Nominal Link Gain (Typ.) | +5 dB Gain Tx -10 dB, Rx +15 dB P/N Tx = 04, P/N Rx = 05 | +20 dB Gain Tx +5 dB, Rx +15 dB P/N Tx = 01, Rx = 05 | +10 dB Gain Tx -10 dB, Rx +20 dB P/N Tx = 04, Rx = 03 |
| Impedance | 50 Ohm | 50 Ohm | 50 Ohm |
| Noise Figure (Typ. @ 1500 MHz) | 20 dB | 10 dB | 20 dB |
| Noise Figure (Typ. @ 3500 MHz) | 23 dB | 12 dB | 23 dB |
| Noise Figure (Typ. @ 6000 MHz) | 29 dB | 19 dB | 29 dB |
| RF Isolation (Typ.) | >60 dB | >60 dB | >60 dB |
| VSWR (Typ.) | 1.5:1 | 1.5:1 | 1.5:1 |
| Gain Stability over Temperature (Typ.) ^a | +/-3 dB | +/-3 dB | +/-3 dB |
| SFDR (Typ. @ 1500 MHz) | 109 dB / Hz (2/3) | 109 dB / Hz (2/3) | 109 dB / Hz (2/3) |
| SFDR (Typ. @ 5 GHz) | 104 dB / Hz (2/3) | 104 dB / Hz (2/3) | 104 dB / Hz (2/3) |
| Optical Wavelength | 1310 nm (Default) CWDM 1270-1610 nm ± 3 nm | | |
| TX Laser type | DFB - Distributed feedback laser | | |
| Optical Power Output (Typ.) | 4.5 dBm | | |
| Additional control features | Software controllable parameters via USB-C cable (Black & Blue OEM), p/n 55058 Software controllable parameters via SNMP (Rack card) Antenna Fault Detection (AFD), senses LNA current feed | | |
| Maximum RF input power without damage | +20 dBm | | |
| Operating temperature | -20 °C to +60 °C (OEM Modules) | | |
| Humidity | 0-95 % non-condensing | | |
| Cooling | Convection | | |
| Power consumption | Transmitter: 1.8 W typical Receiver: 1.2 W typical | | |
| DC Input voltage | OEM Modules Only 8-15 V, 12 V nominal (>18 V damage) | | |
| Power supply compatibility | Blue OEM p/n HPS-CP-W, OEM power supply, DC plug connector, wall mounting Black OEM p/n 73955 OEM power connector, 2m cable, bare wire end or p/n HPS-CY, OEM power supply, wall mounting, requires AC mains connection | | |
| RF module Types | Rack plug-in module : 1xTX, 1xRX, 2xTX, 2xRX, 1xTRX Blue OEM module: 1xTX, 1xRX Black OEM module: IP55 Rated 1xTX or 1xRX | | |

^a measured across a temperature window of 40 °C

7 **Maintenance and fault finding**

7.1 **Green status indication**

The **ViaLiteHD** 6 GHz Links are designed to work right ‘out of the box’ such that once powered and joined with an optical cable, the RF link will function at default settings. The transmitter module should show a green light indicating nominal laser power has been achieved and the receive module should show a green light indicating laser light power is being received. The receiver green light however, does not inform as to the amount of laser power being received and most performance issues are related to light attenuation between the transmitter and receiver. The OEM USB-C command line interface cable (55058) or **ViaLiteHD** System Monitoring & Control Module (HRC-3) can be used to report the received light level (RLL) and this is the first place to look if the performance isn’t as expected yet the Status indicators are green. For optimal operation, the RLL should report > 3.0 dBm. A figure above 4.0 dBm implies that optical losses are minimal.

Common causes of optical attenuation through the link are:

- **Incorrect fibre cable connectors.**
Ensure Angled Polished Connectors (APC) are used.
APC are used to minimise back reflections at the connection points and provide for the higher quality link required of analogue over fibre systems.
- **Dirty fibre connectors.**
Prior to mating optical connections, ensure both sides are clean. See 2.2.3.
- **Incorrect fibre optic cable.**
Ensure only single mode fibre is used.
Multi-mode fibre – as used by digital short range systems – will not work.
- **Bend radius of fibre exceeded.**
Optical fibre that is bent beyond its designed minimum bend radius will introduce optical loss due to a scattering of the light inside the fibre core. Minimum bend radius can vary significantly from 5mm up to as much as 30mm!
- **Crushed fibre.**
A fibre that has been crushed or squeezed can introduce significant attenuation. Ensure the length of fibre is in good condition.

7.2 **Red status indication**

If any of the **ViaLiteHD** 6 GHz Link components have a red status indication light, the link will likely be down. If all the bullet points above can be ruled out as causes, then further investigation can be made by querying the error state either via the USB command line interface or web GUI.

An example output from the command line interface may be the following (see 2.7 for command line access):

```
> system:errors?
I: 4
64: System error (24 s ago)
7b: Under temperature (24 s ago)
7d: RF power low (24 s ago)
81: RLL low (0 s ago)
```

The most common error codes are returned with text explanations. In the unlikely event of a system error code that can’t be resolved by the user, please contact your local sales representative who can assist further.

8 **Product warranty**

The guarantee / warranty period, unless otherwise agreed in writing, shall be as stated in document F292 - PPM Manufactured Product – Warranty, which is available at: <https://ppm.co.uk/warranty-periods/>. Extended warranty options are available at the time of purchase.

Prior to returning any goods for warranty or non-warranty repairs please contact PPM / **ViaLite Communications** for a returns reference.

© PULSE POWER & MEASUREMENT LTD 2024.

NO PART OF THIS DOCUMENT MAY BE REPRODUCED OR TRANSMITTED IN ANY FORM WITHOUT PRIOR WRITTEN PERMISSION.

PULSE POWER & MEASUREMENT LTD, 65 SHRIVENHAM HUNDRED BUSINESS PARK, SWINDON, SN6 8TY, UK.

TEL: +44 1793 784389

FAX: +44 1793 784391

EMAIL : SALES@VIALITE.COM

WEBSITE : WWW.VIALITE.COM